

Amana®

Model ERGW with EBWC

Installation Instructions For HTM Plus Remote Heating Unit

IMPORTANT TO THE INSTALLER

Before installing this unit please read this manual to familiarize yourself on the specific items which must be adhered to such as maximum external static pressure to unit, air temperature rise, min. or max. cfm and motor speed connections. Affix these Installation Instructions adjacent to the furnace.

TO THE OWNER

It is important that you fill out the owner's registration card and mail it today. When filling in the registration card, be sure to include the Model, Manufacturing and Serial Numbers, plus the installation date.

Your warranty certificate is also supplied with the unit. Read the warranty carefully and note what is covered. Keep the warranty certificate in a safe place, so you can find it, if necessary.

If additional operating instructions are required, call the dealer through whom the purchase was made.

Keep this literature in a safe place for future reference.

WARNING

Should overheating occur or the gas supply fail to shut off, turn off the manual gas control valve to the appliance.

WARNING

FOR YOUR SAFETY

Do not store or use gasoline or other flammable vapors and liquids in the vicinity of this or any other appliance.



RECOGNIZE THIS SYMBOL AS A SAFETY PRECAUTION.

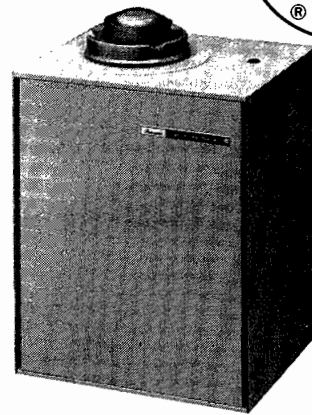
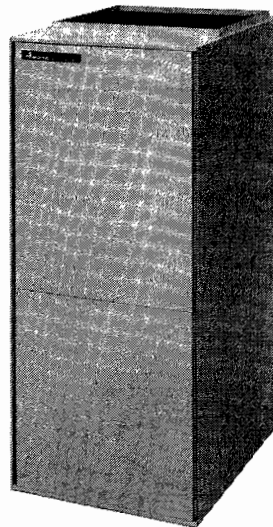

WARNING

Improper installation, adjustment, alteration, service or maintenance can cause injury or property damage or death. Refer to this manual. For assistance or additional information consult a qualified installer, service agency or the gas supplier.



WARNING

FOR YOUR SAFETY WHAT TO DO IF YOU SMELL GAS

- Do not try to light any appliance.
- Do not touch any electrical switch.
- Do not use any phone in your building.
- Immediately call your gas supplier from a neighbor's phone. Follow the gas supplier's instructions.
- If you cannot reach your gas supplier, call the fire department.

THE INSTALLATION AND SERVICING OF THIS EQUIPMENT SHOULD BE PERFORMED ONLY
BY QUALIFIED, EXPERIENCED TECHNICIANS.

Part No. A34144-8

Due to policy of continual product improvement, the right is reserved to change specifications and design without notice.

SPECIFICATIONS

OUTDOOR HEATING UNIT

Model	ERGW0012-1A	ERGW0015-1A
Heating Max. BTUH Input	120,000	150,000
Heating Capacity BTUH/AFUE**	99,000/82.4	
Heating Capacity Input	100,000*	
Heating Capacity BTUH/AFUE**	84,000/83.4	
Heating Min. BTUH Input	80,000	130,000
Heating Capacity BTUH/AFUE**	67,000/84.2	
Pump and Combustion Blower Motor H.P./RPM	1/4/3300	1/4/3300
Ignition—Ignitor Warm Up, Seconds	45	45
Lock Out Timing, Seconds	15	15
Heating solution required, with indoor section only and 40' of 3/4" OD pipe, gals. (50% Ethylene Glycol and Distilled Water)	Approx. 5.5†	Approx. 5.5†
Heating solution required, with indoor section, water heater and 40' of 3/4" OD pipe, gals. 50% Propylene Glycol and (Distilled Water)	Approx. 6.5†	Approx. 6.5†
Gas Connection Male IPS	1/2"	1/2"
Electrical Data—60 Hertz (a)		
Voltage, Single Phase	115	115
Maximum Over Current Protection, Amps	15	15
Maximum Input Amps	8.1	8.1
Wire—Number and Minimum Size (AWG)	(2) 14	(2) (14)
Ground Wire, AWG (Chassis Ground)	(1) 14	(1) (14)
Shipping Weight, Approximate Pounds	92	98
Net Weight, Approximate Pounds	83	89

*Input as shipped from factory with natural gas orifice plate. Unit may be re-rated with factory supplied orifice plates. Unit may be field converted for propane gas, with factory supplied orifices.

**Amana tests based on DOE test procedures. See nameplate for CGA certified output ratings. AFUE ratings shown are for natural gas.

†Dependent on relative location of outdoor and indoor sections.

INDOOR BLOWER COIL

Model	EBWC3612M-B	EBWC6015M-A
Heating Coil Face Area Square Feet	3.06	3.66
Rows Deep	3	3
Fins/inch	16	16
Tube O.D. inches	3/4	3/4
Air Circulating Blower Wheel—Quantity	1	1
Diameter x Width, Bore, Inches	10 x 7, 1/2	10 x 10, 1/2
Blower Motor, Horsepower	1/2	3/4
Type	PSC	PSC
Number Speeds	3	3
External Static Pressure Inches	Min. .2	Min. .2
Water Column	Max. .5	Max. .5
Air Temperature Rise Range °F	60-90	60-90
Electrical Data—60 Hertz (a)		
Maximum Overcurrent Protection, Amps	15	15
Voltage Single Phase	115	115
Maximum Input Amps	9.7	10.0
Wire—Number and Minimum Size	(2)—14	2—14
Ground Wire AWG	1—14	1—14
Filter—Permanent Filter	(1)-16 x 25 x 1"	(2)-16 x 25 x 1"
Shipping Weight, Approximate Pounds	152	154
Net Weight, Approximate Pounds	140	142

(a) IMPORTANT—While the above data is presented as a guide, it is important to electrically connect properly sized overcurrent devices and conductor wires in accordance with the National Electrical Code Canadian Electrical Code Standard CSAC221 and all existing local codes.

DIMENSIONS

OUTDOOR UNIT

MODEL	A
ERGW0012-1A	37/8
ERGW0015-1A	63/8

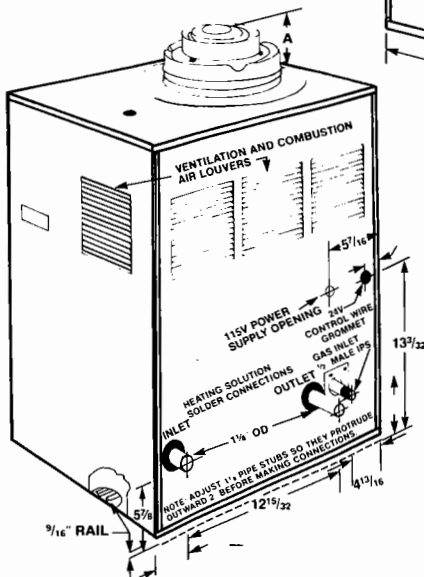

FIGURE 2

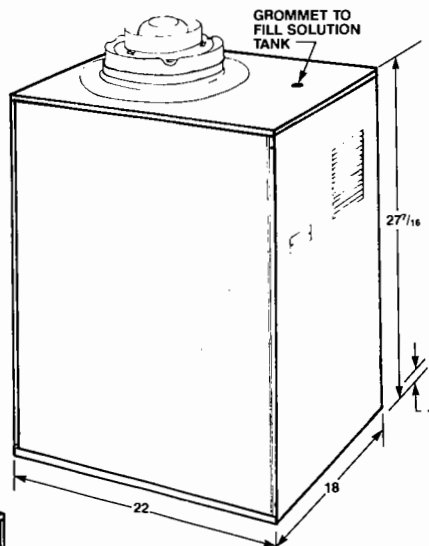

FIGURE 1

DIMENSIONS

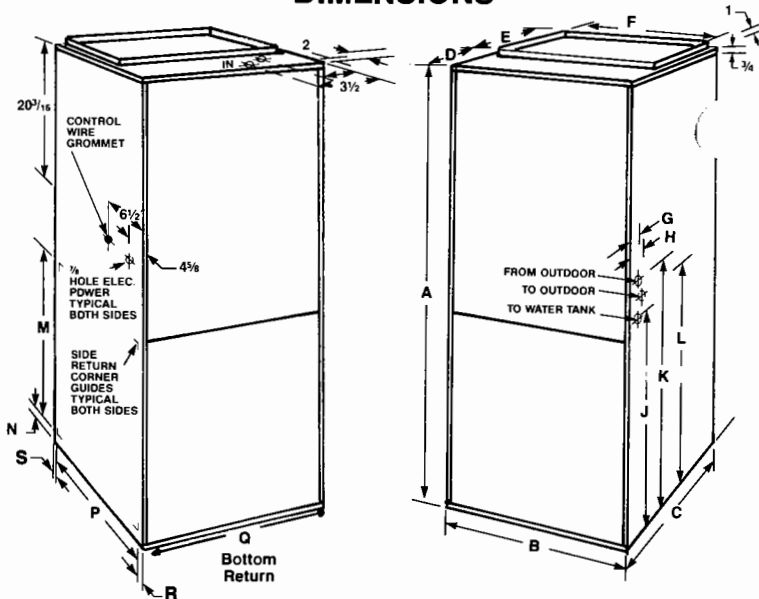

FIGURE 3

FIGURE 4

MODEL	A	B	C	D	E	F	G	H
EBWC3612M-B	48.00	24 1/2	28.00	7 1/4	20	23	1 15/16	4.00
EBWC6015M-A								

MODEL	J	K	L	M	N	P	Q	R	S
EBWC3612M-B	21	24	22 3/4	14.00	1 5/8	23	18	3 1/2	1 1/2
EBWC6015M-A									

OUTDOOR UNIT CLEARANCE

Minimum:
 Front: 36"
 Sides 6"
 Rear 12"
 Top: Un-obstructed 36"
 Roof overhang permissible

INDOOR BLOWER-COIL

SERVICE ACCESS

Front: 36"
 Sides: 12"
 Rear: 0"

Operational clearance
 0" on all sides, top, bottom
 and duct work.

*For additional clearances, refer to page 4 and the "Outdoor Unit Location" section.

DESCRIPTION

The Remote HTM® Plus System is a unique means of heating which supplies warm air through a duct system and having the option of also supplying domestic hot water. The gas heating unit is installed outdoors and, therefore, no indoor flue is required. A glycol solution heated in the HTM (Heat Transfer Module) is pumped through tubing to an indoor air handling unit which consists of a finned tube coil and blower to supply warm air through a duct system. A valve may be installed which will divert the heating glycol solution to a finned tube coil immersed inside a hot water tank to heat domestic tap water.

RECEIVING

Upon receipt of the unit, the equipment should be inspected for any damage which may have occurred in transit. If damage is obvious, it should be noted on the carrier's freight bill and a request for inspection and settlement of claim made at once. Units are usually shipped F.O.B. and it is the consignee's responsibility to file damage claims.

VENT CAP SEAL

Silicon RTV (Room Temperature Vulcanizing) Sealant should be used to fill gaps between flue cap, wrapper, and O rings, if required. Inspect after assembly to determine that all gaps have been sealed. Leaks can be detected by placing an inspection mirror below flue cap seal. The mirror is then moved around perimeter of flue cap. Look for fogging of mirror due to warm moist flue products striking the cooler mirror.

OUTDOOR UNIT LOCATION

This unit is approved for outdoor installation only. An extension of the flue cap or addition of a flue pipe is not sanctioned or approved. The outdoor unit should be installed on a concrete slab at least 2" larger than the unit on all sides. In addition to the picture shown (Fig. 5) for required clearances to the unit, the unit must be at least four (4) feet horizontally from a window, door, soffit vent or other air opening into the building. No wood patio should be constructed over the unit at a later date. Maintain service clearance of 36" from the front of the unit. Maintain clearance of 6" on all sides for proper airflow.

Side and rear louvers must be unobstructed to assure adequate combustion and ventilation air.

Gutters or deflectors must be installed on the roof to prevent water from shedding on the unit.

The location of the outside unit should be picked to provide the most direct piping to the indoor air handler and the optional water heater.

GAS CONNECTIONS AND PLUMBING

Installation must conform to local codes or in the absence of local codes, the National Fuel Gas code, ANSI Z223.1-1984 or National Standards of Canada Manual B-149-1 Installation Code for Natural Gas Appliance must be followed in installing the gas piping. Use a pipe joint compound resistant to both natural and liquified petroleum gases. Remove protective cap from 1/2" IPS nipple and install a ground joint union, then a nipple, tee, plus a 4" nipple with the lower end capped to make a drip leg. See sketch to the right. Galvanized pipe and fittings are not recommended.

The drip leg is important to prevent foreign matter and condensate from entering the gas valve. The cap may be removed to drain condensate from the line and drip leg.

OPTIONAL HOT WATER TANK

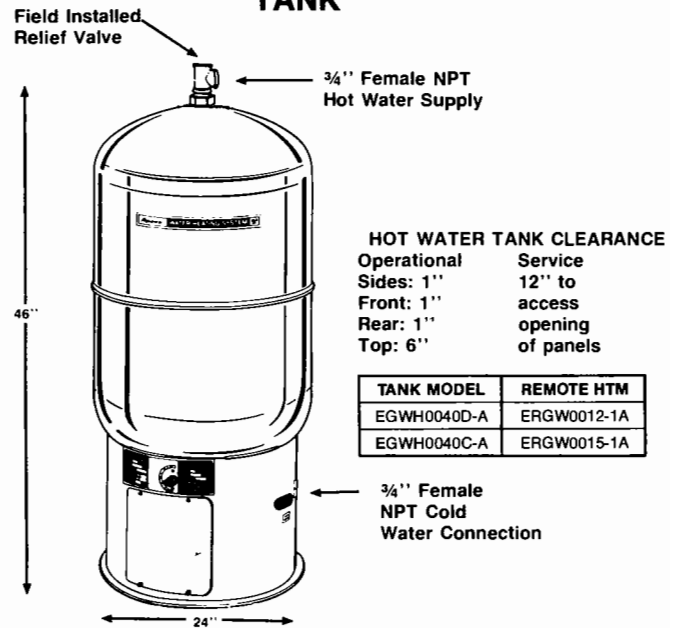

NO WINDOWS, DOORS, OR SOFFIT VENTS WITHIN 4 FEET OF UNIT

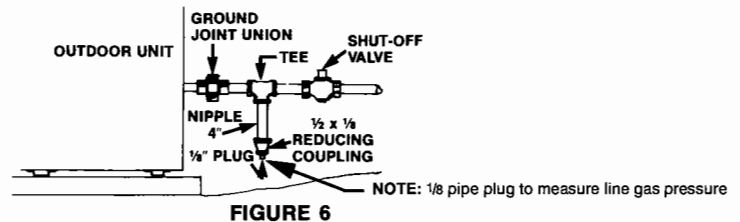
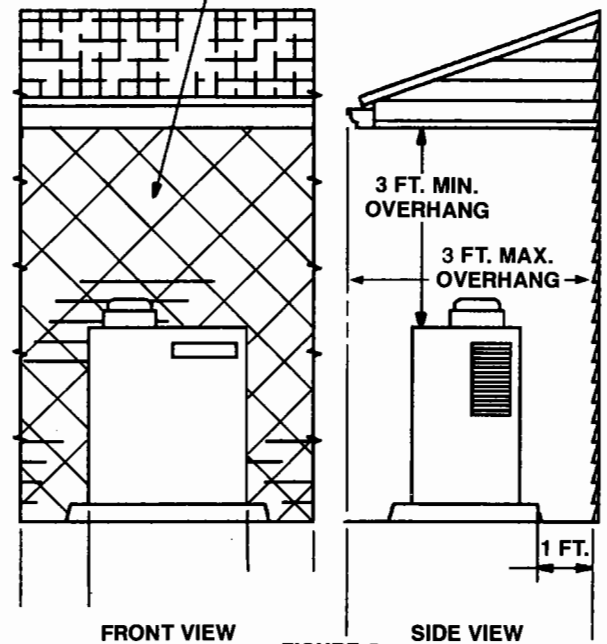

INLET GAS PRESSURE		
NATURAL	NORMAL 7"	MIN. 3.5", MAX. 10.5"
PROPANE	NORMAL 11"	MIN. 8", MAX. 13.0"

FIGURE 7
INLET GAS PRESSURE MUST NOT EXCEED THE MAXIMUM VALUE SHOWN IN TABLE ABOVE.



CAUTION

To avoid the possibility of property damage, personal injury or fire, the following instructions must be performed regarding gas connections, pressure testing, location of shut off valve and installation of gas piping.



The unit and its gas connections must be leak tested before placing in operations.



This unit and its individual shut-off valve must be disconnected from the gas supply piping system during any pressure testing of that system at test pressures in excess of 1/2 psig (3.48 kPa).



This unit must be isolated from the gas supply system by closing its individual manual shutoff valve during any pressure testing of the gas supply piping system at test pressures equal to or less than 1/2 psig (3.48 kPa).



The shut off valve should be located in a convenient location (within (6) six feet of unit) between the meter and the unit. Proper sizing of gas piping depends on the cubic feet per hour of gas flow required, specific gravity of the gas and the length of the run. Lay out the piping plan and refer to the code manual to obtain the correct pipe sizing for each branch run, etc.



When installing the gas piping to the unit, be sure to hold the nipple extending out of the rear of the unit with a pipe wrench. This will prevent the unit nipple and gas valve from rotating or causing undue strain on the combustion blower and motor.

UNIT CONVERSION FOR PROPANE, TANKS AND PIPING

The unit referred to in this manual is shipped for operation on natural gas. To operate the unit on propane, a conversion orifice plate must be installed. The re-rating air/gas orifice plates for natural gas and conversion plates are factory supplied with the unit. See unit instruction plate or "FUEL AND INPUT SELECTION" section for information regarding changing air/gas orifice plates.

All propane gas installations must conform to the safety standards of the National Board of Fire Underwriters (See NFPA Manual 58) or in Canada with National Standards of Canada B149.2 Installation Code for Propane Gas Burning Appliance.

For satisfactory operation, the propane gas pressure must be 11 inch W.C. at the unit valve inlet under full load. Maintaining proper gas pressure depends on three main factors:

1. Vaporization rate, which depends on (a) temperature of the liquid, and (b) "wetted surface" area of the container or containers.
2. Proper pressure regulation. (Two-stage regulation is recommended from the standpoint of both cost and efficiency.)
3. Pressure drop in lines between regulators, and between second stage regulator and the appliance. Pipe size required will depend on length of pipe run and total load of all appliances.

Complete information regarding tank sizing for vaporization, recommended regulator settings, and pipe sizing is available from most regulator manufacturers and propane gas suppliers.

Please refer to the following illustration for typical propane gas installations.

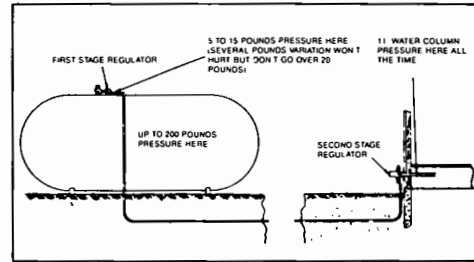

FIGURE 8

LOCATION—INDOOR UNIT AND WATER TANK

The indoor unit and water tank must not be located more than 15 feet vertically above the outdoor section. The indoor air handler can be positioned horizontally, upflow or counterflow. If in a horizontal or counter flow position, the blower motor must be rotated in its mount to position the oilers to the top for proper oiling.

Place the indoor air handler unit in a location or position to meet the duct requirements. See duct sizing and installations section. Installation may be made at zero clearance from combustible material; however, access to the front panels must be provided to service the blower and controls.

The appliance shall not be installed directly on carpeting, tile or other combustible material, other than wood flooring.

If a water heater is to be installed either now or at a future date, allow room for installation on either side of the air handling unit.

The water heater tank should be located in an area which will not be exposed to freezing temperatures.

The installation of the hot water tank must be accomplished in such a manner that if the tank or tank connections(s) should leak, the leakage flow of water or heating solution will not cause damage to the adjacent area or to the lower floors of the structure.

A suitable drain pan may be installed under the water heater tank when such locations can't be avoided. The drain pan may be 1 1/2 inches deep and have a minimum length and width of at least 2 inches greater than the hot water heater tank's diameter. The drain pan should have 3/8" OD (3/4") drain pipe and it should be piped to an adequate drain as per local code.

NOTE: Hot water tank must not be used for or contain materials that are caustic, corrosive or flammable, and must be compatible with copper and polyethylene. Pressure must not exceed 100 psi.

FILTERS - EBWC6015M-A

This furnace is equipped with two permanent washable high-velocity filters. Those filters must be cleaned periodically following filter manufacturer's instructions on the filter. If replacement of the permanent type filters supplied with the furnace ever become necessary, they must be REPLACED WITH FILTERS OF THE SAME TYPE. DISPOSABLE FILTERS MUST NOT BE USED. Filter size required is 16 x 25 x 1.

Return air openings shall be cut in each side panel, or on one side and the bottom. A 20 x 25-1 size filter must be used, when one return air opening is on the bottom of the furnace. Refer to the FILTER RETAINER instructions on the filter retainer and the sketch below for installation information.

The bottom of the cabinet has to be removed (knocked or cutout) before the furnace is positioned on the raised platform or set on top of the return air duct. In order to filter the return

air, a filter has to be installed across the bottom opening.



FIGURE 9

FILTER - EBWC3612M-B

This furnace is equipped with one permanent washable high-velocity filter. This filter must be cleaned periodically following filter manufacturer's instructions on the filter. If replacement of the permanent type filter supplied with the furnace ever becomes necessary, it must be REPLACED WITH A FILTER OF THE SAME TYPE. A DISPOSABLE FILTER MUST NOT BE USED. Filter size required is 16 x 25 x 1.

A 20 x 25 x 1" filter must be used when the return air opening is on the bottom of the furnace. Refer to the FILTER RETAINER instructions on the filter-retainer and the sketch above for installation information.

RELIEF VALVE

An A.G.A. listed temperature and pressure relief valve must be installed at the time of installation of the heater (Refer to Fig. 10). Local codes shall govern the installation of relief devices.

CAUTION
To avoid personal injury, or property damage, do not plug or remove the temperature and pressure relief valve.

CAUTION
To avoid personal injury or property damage, the drain line piping should slope away from the relief valve discharge and be directed safely to a drain which has sufficient capacity to handle a large amount of very hot water.

Manually operate pressure temperature relief valve at least once a year to insure that waterways are clear. If the temperature and pressure relief valve on the appliance discharges periodically, this is an indication of a problem with the system requiring immediate service. The problem could be caused by installation of this appliance in a 'closed water system'. Thermal expansion in such a system will cause this to occur. Contact your water supplier or local plumbing inspector for remedies for this situation.

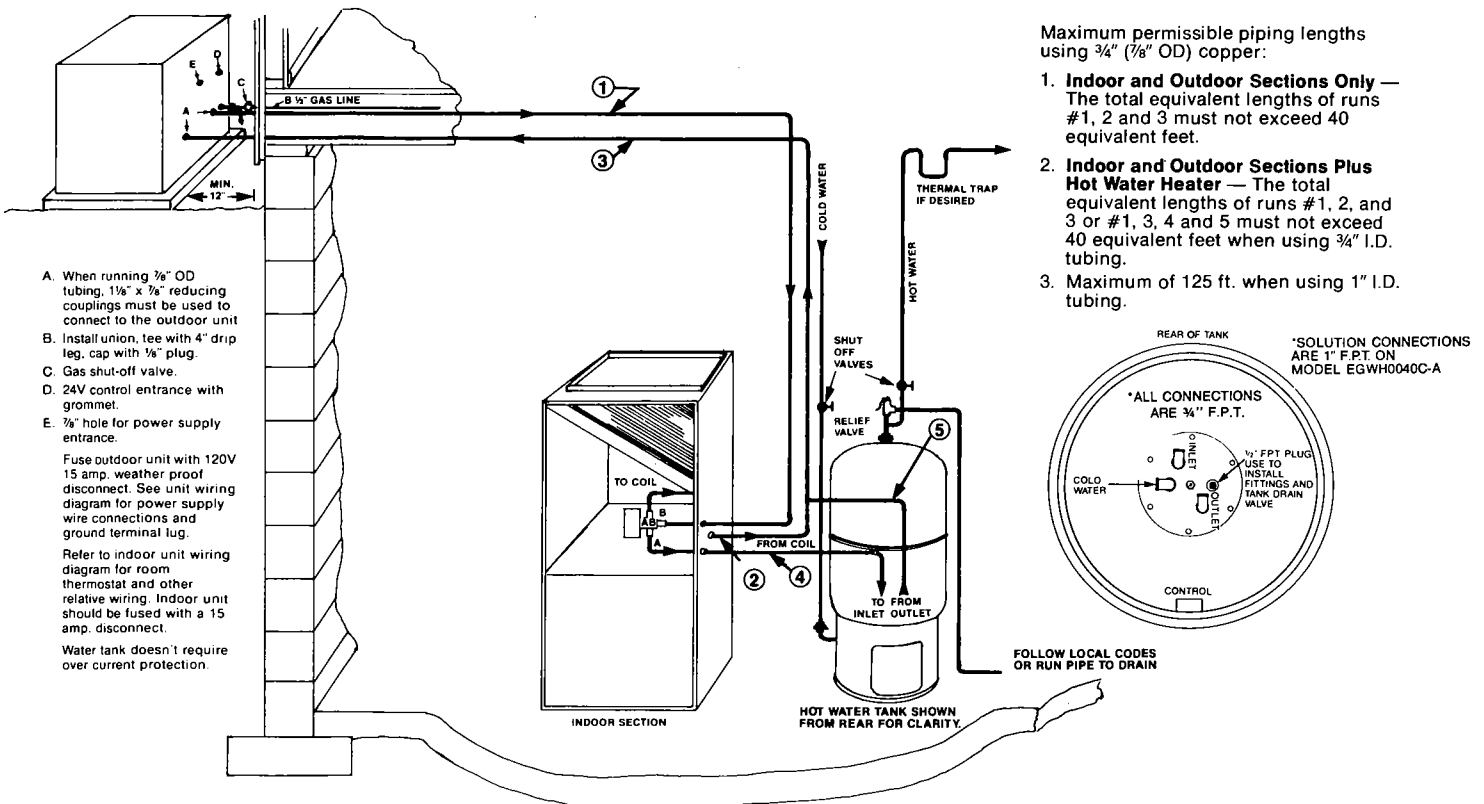

- A. When running 3/4" OD tubing, 1 1/2" x 3/4" reducing couplings must be used to connect to the outdoor unit
 - B. Install union, tee with 4" drip leg, cap with 1/2" plug.
 - C. Gas shut-off valve.
 - D. 24V control entrance with grommet.
 - E. 3/4" hole for power supply entrance.
- Fuse outdoor unit with 120V 15 amp weather proof disconnect. See unit wiring diagram for power supply wire connections and ground terminal lug.
- Refer to indoor unit wiring diagram for room thermostat and other relative wiring. Indoor unit should be fused with a 15 amp disconnect.
- Water tank doesn't require over current protection.

Maximum permissible piping lengths using 3/4" (7/8" OD) copper:

1. **Indoor and Outdoor Sections Only** — The total equivalent lengths of runs #1, 2 and 3 must not exceed 40 equivalent feet.
2. **Indoor and Outdoor Sections Plus Hot Water Heater** — The total equivalent lengths of runs #1, 2, and 3 or #1, 3, 4 and 5 must not exceed 40 equivalent feet when using 3/4" I.D. tubing.
3. Maximum of 125 ft. when using 1" I.D. tubing.

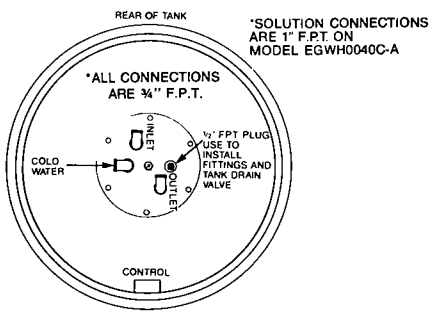

FIGURE 10
SOLUTION PIPING

HEATING SOLUTION PIPING

The heating solution piping should be made up with $\frac{7}{8}$ " OD ($\frac{3}{4}$ " ID) copper tubing and long sweep sweat elbows. Easy flow or equal solder may be used. Do not use silfos, silver solder or equal high temperature melting solders on the diverter valve connections.

The solution piping may be brought into the indoor air handler from both sides through knock-outs provided.

For an installation without the hot water heater, a restrictor pipe is provided with the air handler. Refer to the following pictures for upflow and counterflow installations.

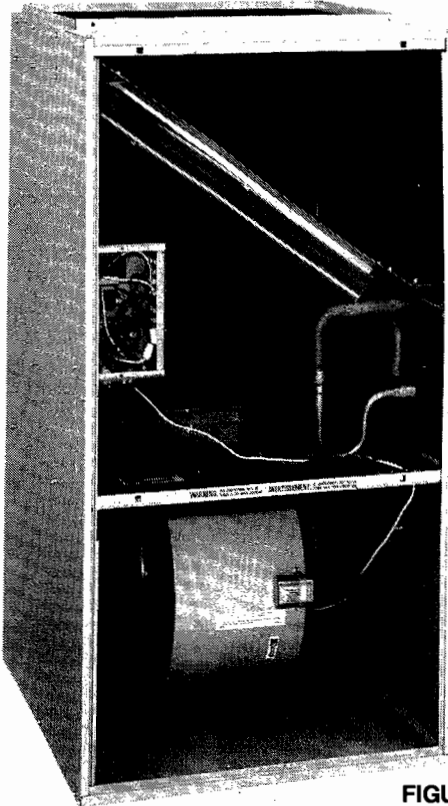

FIGURE 11
UPFLOW SHOW WITH TUBING IN RIGHT HAND EXIT

When the restrictor is used in the system (without hot water tank) in a counterflow system, it may be installed as shown in Figure 12.

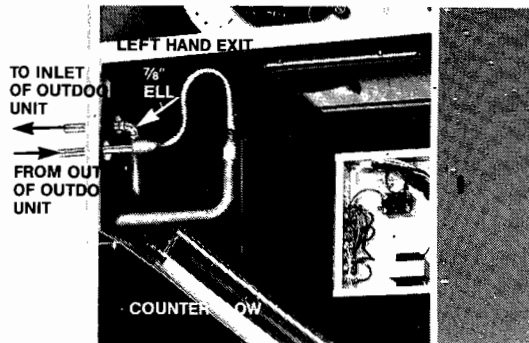

FIGURE 12

The following illustrations show how the diverter valve is installed in the indoor air handler.

The $\frac{7}{8}$ " ID ($\frac{3}{4}$ " ID) (C) elbow is not furnished with the unit. The diverter valve is provided with the hot water tank.

Tail pieces are not furnished and must be field fabricated with sweat elbows as required.

Important: Before any heat is applied to the diverter valve, set the manual opener lever to MAN. OPEN. This will protect the plug inside the valve by removing it from the heat. See Figure 13.

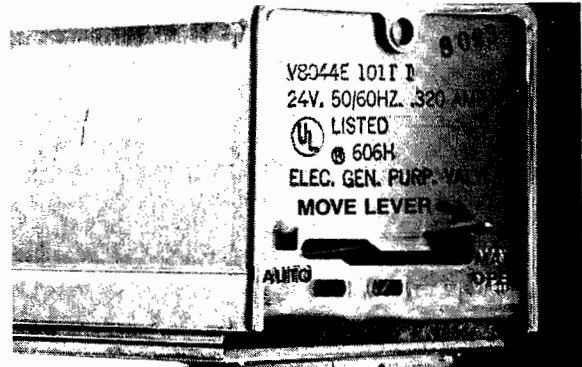

FIGURE 13

Refer to body of diverter valve, letters B, AB and A. They must be located as shown in Figure 14. Tail piece D (not furnished) installs into AB. Tail piece E (not furnished) installs into opening A. Elbow C (not furnished) onto coil outlet. Extend piping to outdoor unit and water tank as shown below and illustration on page 5.

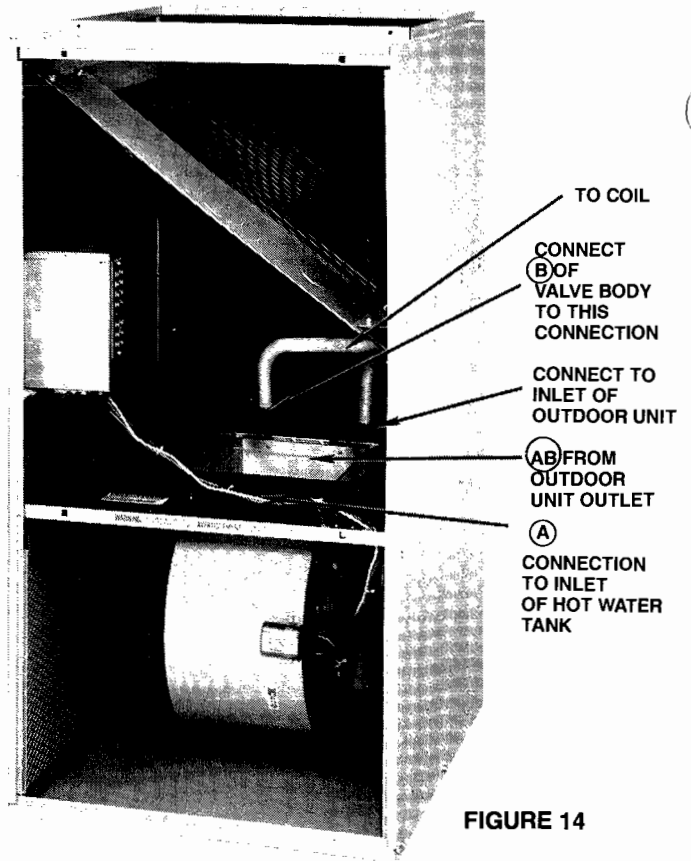

FIGURE 14
PIPING CONNECTIONS FOR WATER HEATER

Refer to Figure 15 and 16 for right hand exit and restrictor tube and left hand exit piping for the diverter valve.

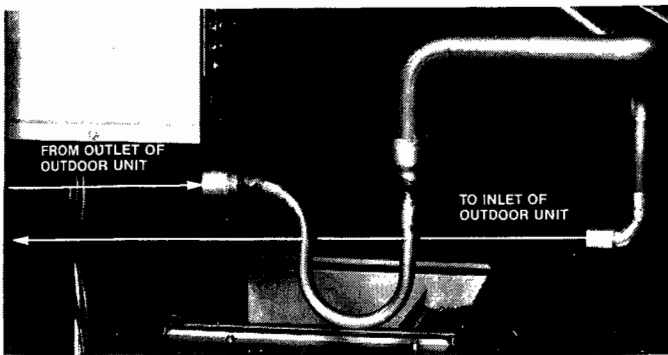

FIGURE 15

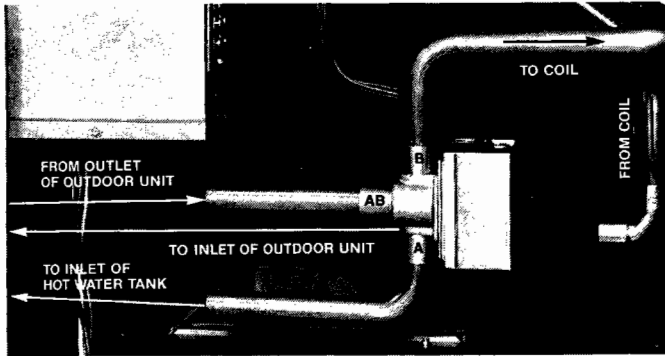
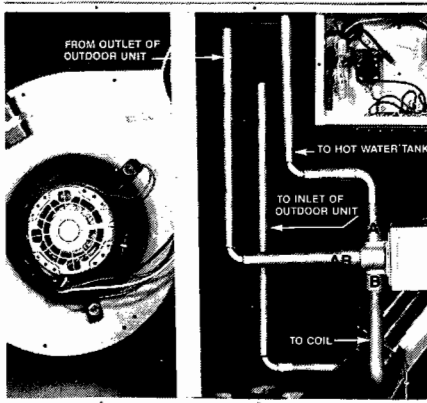
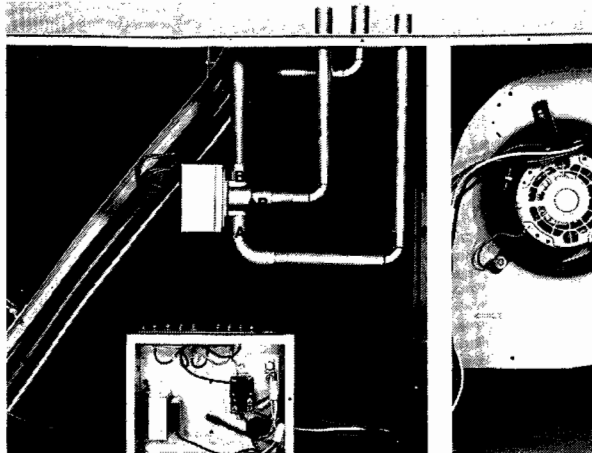

FIGURE 16

Refer to Figure 17 and 18 in relation to installing the diverter valve in the indoor air handling unit in the horizontal position. The diverter valve must be installed in vertical piping. Refer to page 6 regarding location.



RIGHT HAND
AIR FLOW
FIGURE 17



LEFT HAND AIR FLOW
FIGURE 18

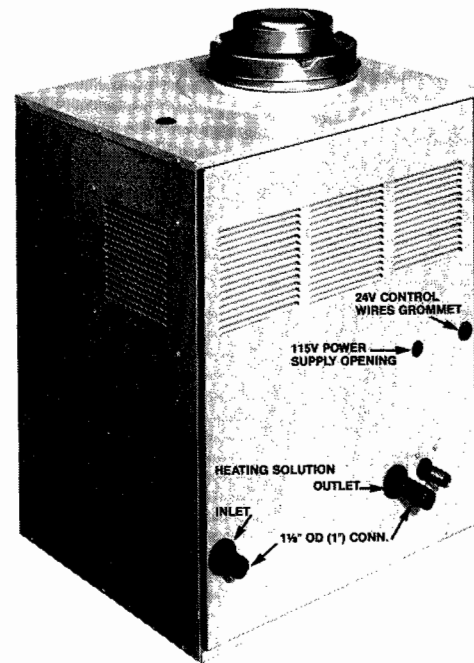

FIGURE 19

It should be noted that the total equivalent length of supply and return piping must not exceed 40 feet and 15 feet of rise. All elbows should be the long radius type. Each elbow is equal to 1.25 feet of $\frac{7}{8}$ " OD ($\frac{3}{4}$ ") pipe, a $\frac{7}{8}$ " tee is equal to 2 feet of pipe. For example: if eight elbows are used, then the actual length must not exceed 30 feet.

It will be necessary to use $\frac{1}{8}$ " OD (1") tubing if 40 feet of pipe is not sufficient to complete the installation. $\frac{1}{8}$ " tubing is ok to use up to 125 feet. ALWAYS MAKE A PIPING LAYOUT SO THE PIPING SIZE CAN BE DETERMINED PRIOR TO THE INSTALLATION.

NOTE: Before the solution piping is connected to the outdoor units, the two stubs must be adjusted to protrude 2" out of the cabinet. This dimension is factory set; however, the dimension can be greatly changed during shipping to its final destination.

The inlet and outlet heating solution connections on the outdoor unit or $\frac{1}{8}$ " MALE OD (1"). When using $\frac{7}{8}$ " OD ($\frac{3}{4}$ ") copper tubing a $\frac{1}{8}$ " x $\frac{7}{8}$ " reducing coupling must be used to inter-connect to the $\frac{7}{8}$ " OD piping, refer to Figure 10 for a TYPICAL PIPED SYSTEM.

If a water heater is to be installed, refer to the installation instructions supplied with tank. **NOTE:** All external solution piping to the indoor, outdoor units and to the water heater tank must be insulated ($\frac{3}{8}$ " wall Rubatex or equal).

ELECTRICAL CONNECTIONS

When installed, the unit must be electrically grounded in accordance with local codes or in the absence of local codes, with the National Electrical Code, ANSI/NFPA No. 70-1987, or, in Canada, Canadian Electrical Code, C22.1-1986.

Refer to page 2 regarding the location for the 115V and 24V control wires, openings or knockouts. See Figure 19 for outdoor unit connection openings. The indoor and outdoor units should be protected by a 15 amp over-current protection device. The outdoor should have a weather proof disconnect adjacent to the unit and a flexible liquid tight conduit run through the opening shown in Figure 20. Termination of the flexible conduit must be made with a connector to the opening provided in the rear of the control panel box. See "A" Figure 20. Size and run the three conductors (black, white and ground) to black and white wires and equipment ground lug as indicated in Figure 20. The 24V control wires should enter

the outdoor unit through the rubber grommet. Wiring must be weather proof. (Conduit or 4 wire weather proof cable.)

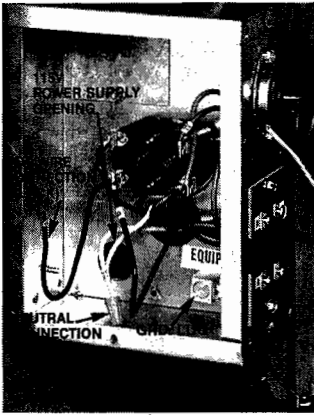

FIGURE 20

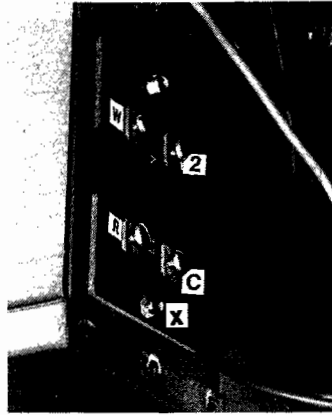

FIGURE 21

To electrically connect the indoor unit from the 15 amp (115V) disconnect switch, refer to the dimension sketch on page 2 for the entrance knockout. Enter the unit through the desired knockout and inter-connect with flexible conduit to open "A" Figure 22. Connect the hot side to the black wire and the neutral to the white wire. The equipment ground wire must be connected to ground lug.

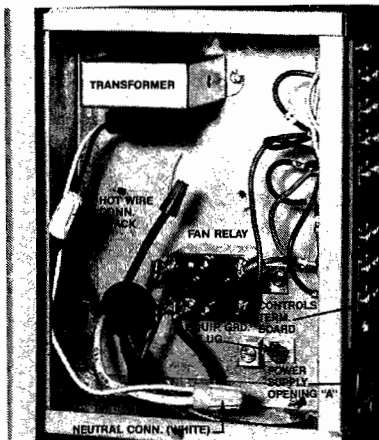

FIGURE 22



FIGURE 23

The unit wiring diagram(s) include the installation of the water heater. The junction box is located adjacent to the cold water inlet. See unit wiring adjacent to the cold water inlet. See unit wiring diagram to determine the terminals to which the two wires from the water heater have to be connected to in the indoor air handling unit.

NOTE: All 24V control wiring may be run with 18 gauge (min.) wires. The wiring diagram shown is a complete control system including air conditioning. If a system is applied for heating only (indoor and outdoor units) a heating only thermostat may be used and connected as shown below.

FAN RELAY

The purpose for the installation of the relay is to deactivate the furnace control timing heater when the system is in the water heating mode (prevents furnace blower operation).

Locate the relay receptacle under the electrical control box in the indoor blower control unit.

To install the relay, remove the jumper wire which is factory installed. The spade connectors of the relay will only fit one way in the relay receptacle.

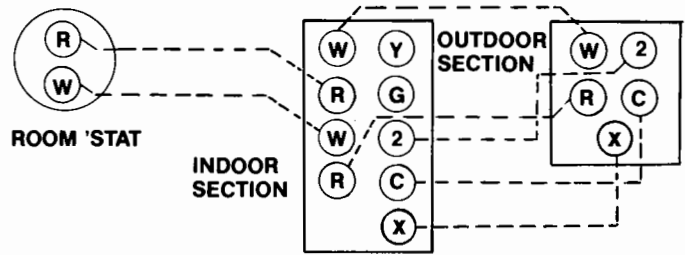

FIGURE 24

NOTE: The information shown in the ELECTRICAL CONNECTION section is only presented as a guide. It is important to electrically connect the units, properly size fuses or overcurrent protection devices and wires in accordance with the National Electric Code, ANSI/NFPA No. 70-1987 and/or all existing local codes.

Field wiring shall conform with the temperature limitation for type T wire (63°F rise).

ROOM THERMOSTAT

The room thermostat must be located in the space to be air conditioned. It should be approximately 5 feet above the floor and must not be subjected to cold or warm air from the supply grilles or exposed to the sun or superficial heat and undue vibration. Please refer to the installation instructions of the room thermostat for more explicit information.

HEAT ANTICIPATOR

The heat anticipator in the room thermostat must be adjusted to obtain the proper number of heating cycles per hour. Set as called out on the unit wiring diagram. (Normal 1.0 information on wiring diagram takes precedence.)

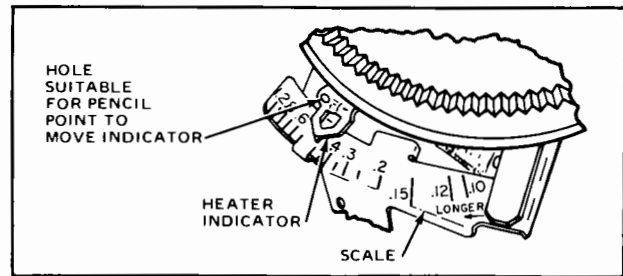

FIGURE 25

DUCT SYSTEM SIZING

Use a recognized standard method for calculating heat loss and heat gain, room by room, as a basis for designing the duct system. ARI 230, NESCA Manual J, or the ASHRAE Guide and Data Book illustrate such methods.

The maximum external static pressures which may be applied, supply and return air ducts, grilles etc. are shown on page 2.

The following general considerations should be taken into account:

1. The units should be as close as possible to those areas which are to be conditioned.
2. If fibrous glass ductwork is used, it must be U.L. approved as a Class 1 Air Duct with a minimum wall thickness of 1" and a 3/4 pound density.
3. Other recommendations for proper ductwork design and installation are as follows:

NOTE: It is not recommended that two indoor units discharge the supply air into a common duct. Each unit should have its own supply and return air duct system.

- a. When ducts have insulation internally, the duct size must be increased by the two thicknesses of insulation. All seams and joints shall be airtight, smooth fitting and taped.
 - b. No abrupt increases, decreases, offsets or 90° turns without turning vanes.
 - c. Large ducts shall not have dimensions whereby the larger dimensions are greater than 4 times the shorter dimensions. Stiffening of ducts should have standing seams or additional reinforcing angles.
 - d. Air velocities in main ducts for residential application should not exceed 1000 FPM and for branches 800 FPM.
 - e. Branch ducts must have volume control dampers, with outside locking devices, to allow the system to be properly balanced. Be sure to use proper take-off fittings for branch runs.
 - f. Supply and return air grilles must be of sufficient size, number and location to prevent objectionable drafts, plus providing balanced air circulation.
 - g. Supply and return air branch ducts shall have a minimum dimension of 6" round or equal.
 - h. All ductwork must be supported with metal straps to prevent sagging.
4. A vinyl coated fireproof cloth connection should be employed on both the supply and return air duct at the unit.
 5. The duct installation and airflow must be adjusted to obtain a temperature rise within the range specified on the unit rating plate. See specifications in relation to minimum and maximum external static pressures.

DUCTWORK INSTALLATION

Indoor supply and return ducts exposed to near outdoor temperature must be insulated with a minimum of 2" fiberglass or equal. Ductwork exposed to the outdoor elements must have two inches of insulation and a weatherproof barrier.

Inside ductwork within the conditional space may be insulated with 1/2" fiberglass internally or externally with a vapor barrier.

Vapor barriers, such as aluminum foil, or equal, shall lap a minimum of three inches at all longitudinal and butt joints. These joints must be securely sealed and stapled. All punctures, tears, or imperfections in vapor barrier must be patched with same material and adhesive.

Ductwork in or below a slab floor must be completely encased in not less than 2 inches of concrete and shall be insulated and vapor-sealed in addition to the slab perimeter insulation. Insulation shall be a minimum of 1", one pound density, fiberglass or equal.

All insulating must be performed in a workmanlike manner and installed in a fashion as recommended by the manufacturer of the insulation and vapor barrier manufacturer.

GLYCOL HEAT TRANSFER SOLUTION

Unit must be charged with Amana HTM Heat Transfer Solution only. This is premixed and should not be diluted. This solution can be used to (minus) -34°F.

If colder temperatures are apt to be encountered, especially if the system is shut down for any extended period of time, a 55% solution must be used.

SOLUTION CHARGING PROCEDURE

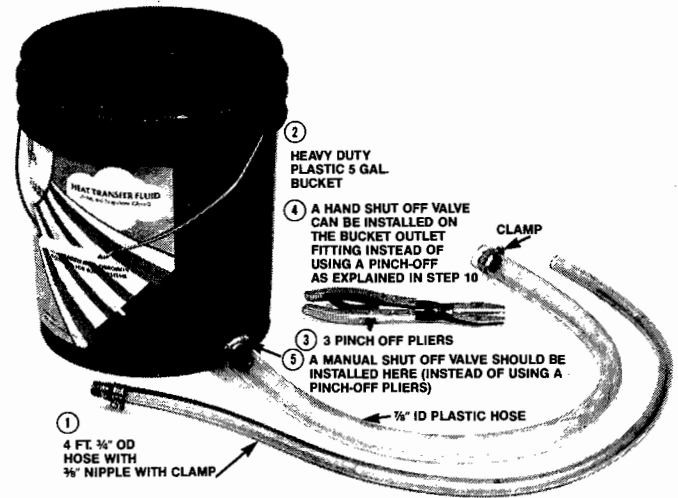

FIGURE 26

Figure 26 illustrates the items which are required to charge the system with glycol solution.

1. Four feet of transparent 3/4" OD hose with a 3/8" nipple secured with a hose clamp.
2. A heavy duty five gallon plastic bucket with a shut-off valve and four feet of 3/8" ID hose attached with a fitting near the bottom. **NOTE:** A six foot long hose may be used to siphon over the top of the bucket. (Not recommended.)
3. Three pairs of pinchoff pliers. (KD No. 45) or equal.
4. Six inches of 18 gauge jumper wire.
5. Sufficient glycol and distilled water to fill the system. See page 2 for approximate quantity.



WARNING

Amana ethylene glycol heat transfer solution contains ethylene glycol which is harmful or fatal if swallowed. Accidental poisoning can cause central nervous system effects, metabolic acidosis, kidney effects. It may also cause eye irritation.

Based on animal data: Ethylene glycol is a possible birth defect hazard. Repeated exposure may cause kidney and liver effects.

Do not drink product or solution. Avoid contact with eyes, skin or clothing. Wash thoroughly after handling.

First Aid: If swallowed induce vomiting immediately as directed by medical personnel. Never give anything by mouth to an unconscious person. Get medical attention. In case of contact, immediately flush eyes with plenty of water. Call a physician if irritation persists.

General Procedure:

The HTM system is a continuous loop which is vented to the atmosphere at the expansion tank.

To charge a unit correctly requires the entire loop be filled with glycol solution without introducing air into the system.

To prevent air from being trapped in the piping or heat exchangers, it is most important that the loop is charged from one side only. Charging from one side of the loop allows air to be forced through the piping and heat exchangers and then expelled into the air vent at the expansion tank.



WARNING

To avoid the hazard of electrical shock, personal injury or death, before performing any of the following steps, disconnect this unit from all electrical power.

1. Remove (Fig. 27)
 - A. Flue Cap
 - B. Pipe plug from module top
 - C. Fill plug
 - D. Ignitor module electrical plug
 - E. Cap from charging tee
2. Install (Fig. 28)
 - A. Charging hose from fill bucket to charging tee (charging hose)
 - B. Hose from top of module to expansion tank (Module hose) (Use split grommet at top of expansion tank)

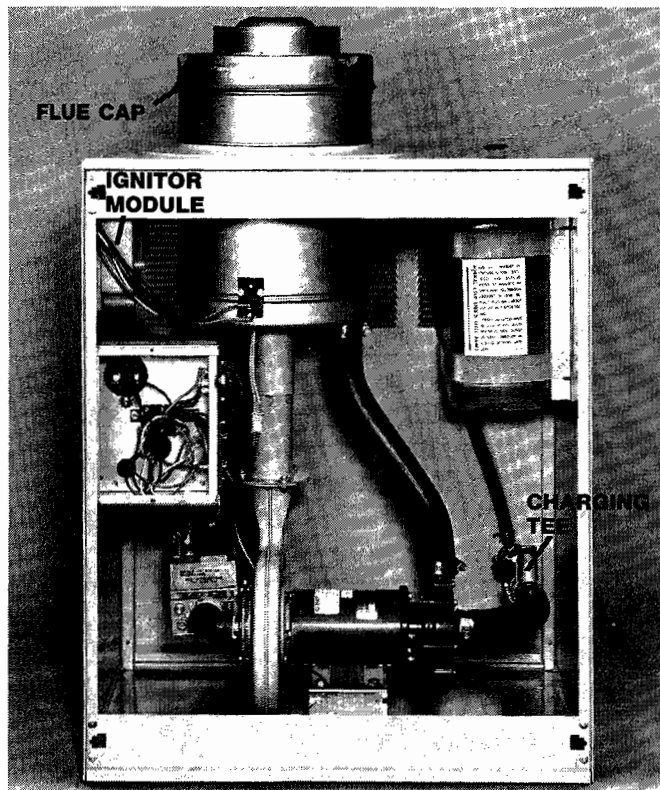

FIGURE 27

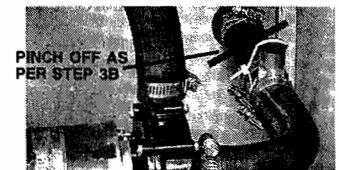
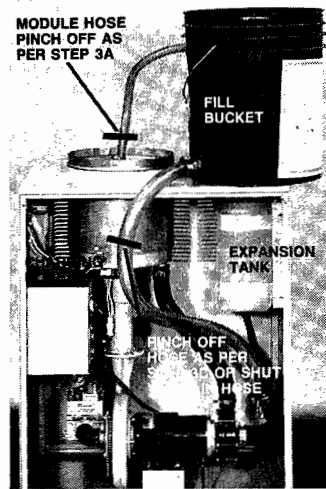

FIGURE 28

3. Pinch Hoses (Fig. 28)
 - A. At top of module
 - B. Between charging tee and vent tube
 - C. From fill bucket
4. Fill Bucket (Fig. 28) with required solution (See chart 1) and continue to add solution as required to maintain liquid seal at bucket outlet.
5. Open Clamp on charging hose and continue to fill system until expansion tank is half full.

NOTE: If indoor tubing or heat exchanger is above outdoor unit, turn on outdoor pump to circulate solution.
6. Open Clamp between charging tee and vent tube. Turn on pump (if not done previously) and continue to circulate solution until expansion tank is full to top level marked on tank.
7. Water Heater Charging - After all air stops circulating into the expansion tank, charge the water heater by turning water heater thermostat to hot position and circulate solution through the tank hot water coil.

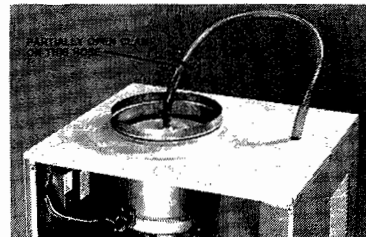

FIGURE 29

8. After both coil and water tank are charged, partially open the module hose (above) and continue to circulate until Module Hose is clear of air.

NOTE: All air must be removed during this step as the unit will not expel air during normal operation.

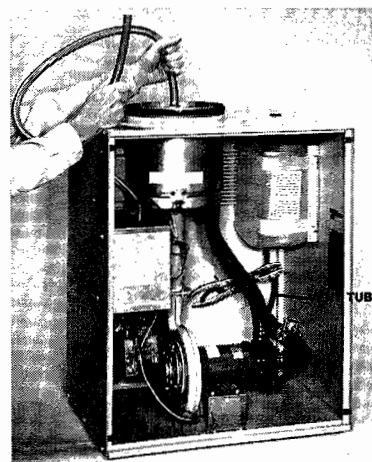

FIGURE 30

9. **Replace** cap on charging tee and module plug.

PROCEDURE: (1) Pinch off rubber vent tube. (2) Remove tube from top of module and replace plug. (3) Keep vent tube and charging hose pinched off. (4) Lower charging bucket below level of charging tee. (5) Remove charging hose and replace rubber plug. (Fig. 30)

10. **Finally**

- A. Install insulation muffler at top of module
- B. Plug in ignition module
- C. Set water heater thermostat to normal (mid-range).
- D. Install flue cap and fiberglass sound ring
- E. Close indoor unit disconnect and run unit through several cycles.
- F. A final check for air:
 - a. Listen for excessive noise from pump surging
 - b. Level of solution should not change excessively in expansion tank during heating operation and when unit is shut down.

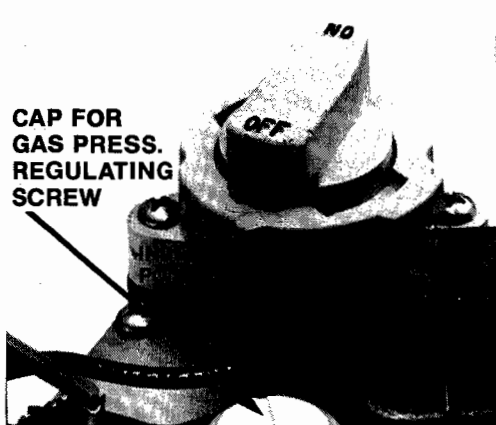

FIGURE 31

GAS TYPE AND INPUT SELECTION

The outdoor unit is factory equipped with a natural gas orifice plate sized for a nominal 100,000 or 150,000 BTUH input. It may be field rerated or converted so it can be used with propane gas. To rerate or convert to propane gas only the air/gas orifice plate has to be changed.

Plates furnished are as follows:

Model	Natural Gas (factory installed)	Additional Orifice Plates		
		Propane	Natural	Propane
ERGW0015-A	150M	150M	130M	130M
ERGW0012-1A	100M	100M	80/120M	80/120M

IMPORTANT: If unit is re-rated, change blower motor speed. Follow instructions as outlined on wiring diagram furnished with unit or this manual.

To change the gas/air orifice plate proceed as follows after the unit electrical switch has been disengaged and the gas valve has been closed.

1. Loosen screws A (3) with 1/4" box or open end wrench. (Fig. 32)
2. Remove screw B.
3. Pull gas/air orifice plate out. (Fig. 33)
4. Install the new plate selected from the tabulation above. All plates are identified by type gas and BTUH gas input. Install plate with stamping towards the valve.
5. Install screw B and tighten screws A. All screws must be drawn up evenly. **DO NOT OVER TIGHTEN OR STRIP THE SCREWS.**

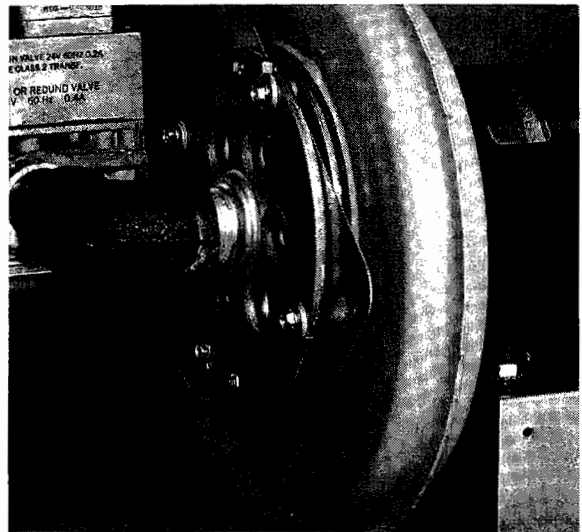

FIGURE 32

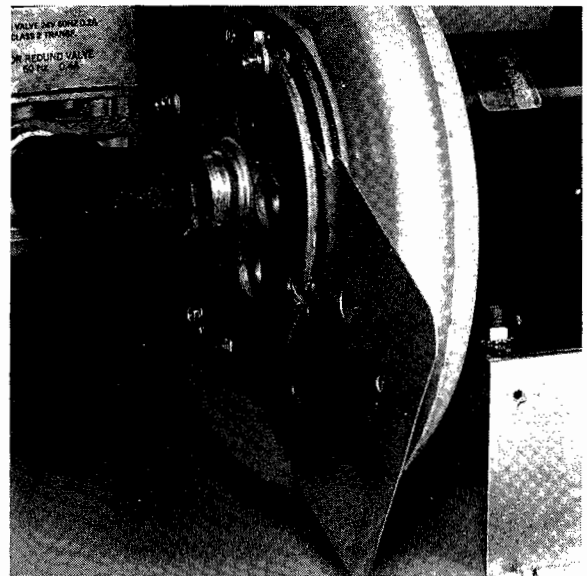

FIGURE 33

6. Remove 1/8" IPS plug from the gas valve and install a 1/8" IPS fitting. Connect a hose between negative side of a manometer or U tube and the fitting.
7. Important: Do not short any 24V leads to ground. A direct short may cause the ignition module or transformer to be replaced. These two components are not to be repaired in the field.



CAUTION

To avoid personal injury or property damage, be certain there is no open flame in the vicinity during air bleeding procedure.

8. There will be air in the gas supply line after testing for leaks on a new installation. Therefore, the air must be bled from the line by cracking open the ground joint union until pure gas is expelled. Tighten union and wait for five minutes until all gas has been dissipated in the air. Be certain there is no open flame in the vicinity during air bleeding procedure. The unit is placed in operation by closing the main electrical disconnect switches for the outdoor unit and the indoor air handler.



FIGURE 34

Turn on manual gas valve and rotate automatic gas valve to the ON position. Refer to Figure 31 regarding gas valve knob and index point.

Turn the room thermostat setting to a point above the room temperature, set the selector switch to HEAT and the fan switch to AUTO. The solution pump/combustion blower motor should start. There probably is still some air in the gas supply line if ignition does not take place.

The unit will shut off in approximately 15 seconds. It will be necessary to move the room thermostat system switch to OFF (without hot water tank in the system) or disengage the air handler disconnect switch (with hot water tank in the system) for at least one minute to allow the ignition module to reset itself. It may take several cycles before the flame is established.

The air circulating blower will keep running after the heat transfer module is off, that is, until the fan stat contacts open. Put the unit through several cycles of about three minutes on and five minutes off. The resultant expansion and contraction of the solution will expel any air that might be in the system.

9. Read the negative gas pressure on the manometer. it should read negative .20 inches water column.

If the reading is higher than negative .10 inches (close to zero) the input will be high. If the reading is lower than negative .30 (further away from zero), the input will be reduced. Readings within these tolerances (plus or minus .10 inches) will allow approximately a \pm 3% BTU input change from the normal.

If the negative pressure doesn't read -.20" remove the cap (see Figure 31) from gas valve and turn adjusting screw accordingly. Replace cap before taking reading.

10. Input to this unit should never exceed the BTUH as shown on the rating plate. Check the gas meter for input to the unit as shown below.

NOTE: On outdoor equipment the gas input will vary with the temperature of the gas. Rated input will be at approximately 10°F. With warmer ambient and gas temperatures, the input will be decreased. For example, at 70°F the input will decrease 12%.

- a. Refer to the one cubic foot dial and observe how long it takes for the dial to make one revolution.
- b. On a 120,000 BTUH unit it should take 32 seconds for the one cubic foot dial to complete one revolution.
- c. Refer to the gas rate chart to determine the cubic feet per hour.
- d. Locate 32 seconds on chart. Follow line across the column under one (1) cubic foot test dial. There we find the value of 113 cubic feet.
- e. Contact the local gas company to obtain the calorific value of the gas supplied.
- f. Multiplying the calorific value of the gas x 113 = BTUH input to unit.

Example: $1050 \times 113 = 118,650$. This test concludes that the unit is operating satisfactorily.

GAS RATE - CUBIC FEET PER HOUR												
Seconds for one Revolution	SIZE OF TEST DIAL					Seconds for one Revolution	SIZE OF TEST DIAL					
	1/2	1	2	5	10		1/2	1	2	5	10	
	cu ft	cu ft	cu ft	cu ft	cu ft	cu ft	cu ft	cu ft	cu ft	cu ft	cu ft	cu ft
10	90	180	360	720	1800	46	25	50	100	200	500	
11	82	164	327	655	1636	37	—	—	97	195	486	
12	75	150	300	600	1500	18	25	47	95	189	474	
13	69	138	277	555	1385	19	—	—	92	185	462	
14	64	129	257	514	1286	40	22	45	90	180	450	
15	60	120	240	480	1200	41	—	—	—	176	439	
16	56	113	225	450	1125	42	21	43	86	172	429	
17	53	106	212	424	1059	43	—	—	—	167	419	
18	50	100	200	400	1000	44	—	—	41	82	164	407
19	47	95	189	379	947	45	20	40	80	160	400	
20	45	90	180	360	900	46	—	—	78	157	391	
21	43	86	171	343	857	47	19	38	76	153	383	
22	41	82	164	327	818	48	—	—	75	150	375	
23	39	78	157	313	783	49	—	—	—	147	367	
24	37	75	150	300	750	50	18	36	72	144	360	
25	36	72	144	288	720	51	—	—	—	141	355	
26	34	69	138	277	692	52	—	—	69	138	346	
27	33	67	135	267	667	53	17	34	—	136	340	
28	32	64	129	257	641	54	—	—	67	135	333	
29	31	62	124	248	621	55	—	—	—	131	327	
30	30	60	120	240	600	56	16	32	64	129	321	
31	—	—	116	232	581	57	—	—	—	126	316	
32	28	56	113	225	563	58	—	—	31	62	124	310
33	—	—	109	218	545	59	—	—	—	122	305	
34	26	53	106	212	529	60	15	30	60	120	300	
35	—	—	103	206	514							

FIGURE 35

On Propane gas installations there is no gas meter to measure the cubic foot per hour gas consumption. It, therefore, becomes necessary to take a manifold pressure reading. It should read negative .20" W.C.

HEATING AIR DELIVERY

The total external static pressure must be checked on the indoor air handling unit to determine if it falls within the maximum and minimum allowable duct static pressures as found in the specification section. Also, the air temperature rise on heating must fall within the range shown on the rating plate and in the specifications.

The indoor blower is not designed to deliver proper air quantities (CFM) against statics other than those listed.

Too great an external static pressure will result in inefficient air that can cause icing of the coil (refrigeration cycle) and/or too high a temperature rise (heating cycle). Whereas too much air can cause poor humidity control (refrigeration cycle) and/or too low a temperature rise (heating cycle). Too much air can also cause motor overloading. In either case, this constitutes a poorly designed duct system.

To determine proper air movement, proceed as follows:

1. Using a draft gauge (inclined manometer) measure the static pressure of the return duct at the inlet of the unit (negative pressure).
2. Measure the static pressure of the supply duct (positive pressure).
3. Add the two readings together.

Recheck the air delivery on heating by placing the unit in operation with the thermostat set high enough to give continuous firing and the fan selector on "AUTO". Install a thermometer in both the supply and return ducts close to the unit. Read after the temperatures have stabilized. The rise (difference between readings) in °F. must fall within the range shown on the rating plate. If the rise is too low, check for proper blower motor wiring in the control panel. If the rise is too high, also check the blower motor wiring for proper speed selection. If blower motor wiring is correct, then it will be necessary to alter the duct system to increase or decrease the static resistance for the correct air flow.

NOTE: When the gas input is increased by using an alternate orifice plate furnished with unit, the heating cfm **must** be increased. When the gas input is reduced by using an alternate orifice plate, the heating cfm must be reduced. Refer to the unit wiring diagram for information on changing the indoor blower motor speed.

**ESP" W.C., CFM, TR (Temp. Rise) DATA @ 10°F
ERGW0015-1A/EBWC6015M-A**

ESP "W.C.	INPUT 150M			INPUT (130M) 150M		
	HI. SPD.	MED. SPD.	TR °F	LOW SPD.	TR °F	
.5	2000	1680	68	1420	(70)	81
.4	2100	1740	66	1480	(68)	78
.3	2200	1780	65	1490	(67)	77
.2	2300	1800	64	1500	(66)	76

Installation is to be adjusted to obtain a temperature rise within the range(s) specified on the Rating Plate.

FIGURE 36

ESP "W.C.	INPUT 120M		INPUT (100M) 120M		INPUT (80M) 100M	
	HI. SPD.	TR °F	MED. SPD.	TR °F	LOW SPD.	TR °F
.5	1375	66	1130	(69) 80	880	(71) 68
.4	1430	64	1150	(67) 79	900	(70) 86
.3	1485	61	1170	(66) 78	905	(69) 86
.2	1540	59	1180	(66) 77	910	(69) 85

Installation is to be adjusted to obtain a temperature rise within the range(s) specified on the Rating Plate.

FIGURE 37

The above information on TR is when the unit is firing at the BTUH INPUT as shown in the tabulation. Full firing is when the incoming gas temperature is approximately 10°F. At 70°F incoming gas the heating capacity is decreased approximately 12%.

COOLING AIR DELIVERY

Usually rated cfm for cooling is 400 cfm for each 12,000 BTU (1 ton) of cooling BTUH. Therefore, the duct work has to be designed accordingly and in conjunction with the pressure drop across the cooling A coil and in relation to the allowable external pressure for the air handling unit.

*ESP" W.C. = External Static Press. Inches Water Column.

**STATIC PRESSURE DROP ACROSS
"A" COIL VERSUS CFM
EBWC6015M-A**

E.S.P. in W.C.	SCFC42AOV-A		SCFC48AOV-A		SCFC60AOV-A	
	Wet	Dry	Wet	Dry	Wet	Dry
.10	945	1140	945	1140	-	1290
.15	1220	1470	1220	1470	1215	1450
.20	1460	1730	1460	1730	1590	1890
.25	1685	1990	1685	1990	1815	2150
.30	-	-	-	-	2020	2380

FIGURE 38

EBWC3612M-B

E.S.P. in W.C.	SCFC18AOV-A		SCFC24AOV-A		SCFC30AOV-A		SCFC36AOV-A	
	Wet	Dry	Wet	Dry	Wet	Dry	Wet	Dry
.05								
.10	610	775	610	775	675	865	865	1225
.15	765	975	765	975	875	1100	1100	1560
.20	880	1125	880	1125	1015	1300	1300	1835
.25	1000	1275	1000	1275	1145	1475	1475	2075
.30	1110	1415	1110	1415	1265	1625	1625	2300

FIGURE 39

For example: The pressure drop across a 48M BTUH (wet) coil is .25" w.c. @ 1685. (See Figure 38). Therefore, the total external static pressure for the supply and return ducts, return air filter, registers may be .25" w.c. (coil .25" w.c. + .25" w.c. for the duct system = a total external static pressure to the of .50" w.c.). The air handling unit should deliver 1130 CFM on medium blower motor speed.

Use a recognized standard method for calculating heat loss and heat gain, room by room, as a basis for designing the duct system. ARI 230, NESCA Manual J, or the ASHRAE Guide and Data Book illustrate such methods.

The maximum external static pressures which may be applied, supply and return air ducts, grilles etc. are as shown on page 2.

COOLING COIL INSTALLATION



The above coils may be used as cooling coils in a field fabricated plenum or using the factory coil cabinet (where available) for an upflow or counter flow application.

COIL—HORIZONTAL APPLICATION

For a horizontal cooling coil application, use the recommended horizontal coil housing assembly. Fabricate a sheet metal transition to interconnect the coil housing and the duct flanges of the air handler. Access door of air handler is recommended to be on top or on the side.

When the air handling unit and cooling coil are located over a finished ceiling an auxiliary drain pan **MUST** be installed under the entire assembly. A separate $\frac{3}{4}$ " drain line should be run to a drain and terminated according to local codes.

OPERATING INSTRUCTIONS

1. Close the manual gas valve external to the outdoor unit.
2. Turn off the electrical power supply to both the indoor unit and outdoor unit.
3. Set room thermostat to lowest possible setting. If a water tank is in the system, set its thermostat to lowest possible setting.
4. Remove the door on the front of the outdoor unit, by removing 4 screws.
5. This furnace is equipped with an ignition device which automatically lights the burner. Do not try to light burner by hand.
6. Turn the gas control valve knob clockwise  to "OFF" position. Do not force. See Fig. 31.
7. Wait five (5) minutes to clear out any gas.
8. Turn gas control valve knob counter clockwise  to "ON." See Fig. 31.
9. Replace the door on the front of the outdoor unit.
10. Open the manual gas valve external to the outdoor unit.
11. Turn on the electrical power supply to both the indoor unit and the outdoor unit.
12. Set thermostat(s) to desired setting.

NOTE: There is a one minute delay between thermostat energizing and burner firing.

TO TURN OFF FURNACE

1. Set the thermostat(s) to lowest setting.
2. Turn off the electrical power supply to both the indoor unit and outdoor unit.
3. Turn the gas control clockwise  to "OFF" position. Do not force. See Fig. 31.
4. Close manual gas shut off valve external to the outdoor unit.
5. Replace the door on the front of outdoor unit.

GENERAL HEATING CYCLE INFORMATION

When the room thermostat is set to HEAT and the fan to AUTO, the system will go into the heating if it is set at a temperature setting higher than the room temperature.

The heating relay in the outdoor unit will close when the contacts in the room thermostat make and thereby starting the pump/combustion blower motor plus energizing the electronic ignition module. The igniter is heated for 45 seconds at which time the gas valve opens. Ignition occurs and the flame is established. The presence of flame is sensed through an electronic signal.

If flame is not established within 15 seconds, power to the gas valve is broken.

The unit will continue to fire until the room thermostat is satisfied at which time the ignition control is de-energized closing the gas valve and the pump/combustion blower motor stops.

The air circulating blower motor starts and stops in response to the fan stat which is a time delay sequencer. This turns the blower on approximately 15 seconds after ignition and turns it off approximately 75 seconds after the heating cycle is completed.

The circuitry in the room thermostat when in the cooling mode, will close the cooling contacts and simultaneously pull in the blower relay to energize the cooling speed and break contacts to the heating speed.

When the thermostat fan switch is set to the ON position, the blower relay activates the cooling speed. It is necessary, that if the fan switch is in the ON position during the heating mode, the blower speed is equal or greater than the normal heating speed.

When the heating cycle is completed, the heating coil cools down and the fan stat opens the circuit to the heating speed.

The electronic ignition module timing sequence starts over with the gas valve closing and the igniter restarting on its 45 second heat up interval, if there is a power or gas interruption.

If the companion water heater is connected into the system, the water heater thermostat takes precedent over the room thermostat temperature setting. The diverter valve motor is energized, when the tank thermostat closes, and drives the solution valve to the water heating position. The diverter valve motor will again drive the valve to the air heating model when the water heater thermostat is satisfied.

Reset After Lock-out;

Should ignition not be achieved, for any reason, within the 15 second lockout period, it is necessary to break power to the electronic ignition module. If a water heater is not used, it is only necessary to turn the room thermostat down below the room temperature for thirty seconds and then resetting to the desired temperatures. However, if a water heater is used, either thermostat may be closed. Therefore, it is necessary to disengage the electrical disconnect to the air handling unit. Power must be off for 30 seconds then engage switch to try for ignition.

System Limit Controls:

The solution limit control sensing capillary measures the temperature of the solution in one of the module tubes. The normally closed contacts of this control will open when the solution reaches a pre-determined temperature which is above normal. See Figure 40 for location of this limit control.

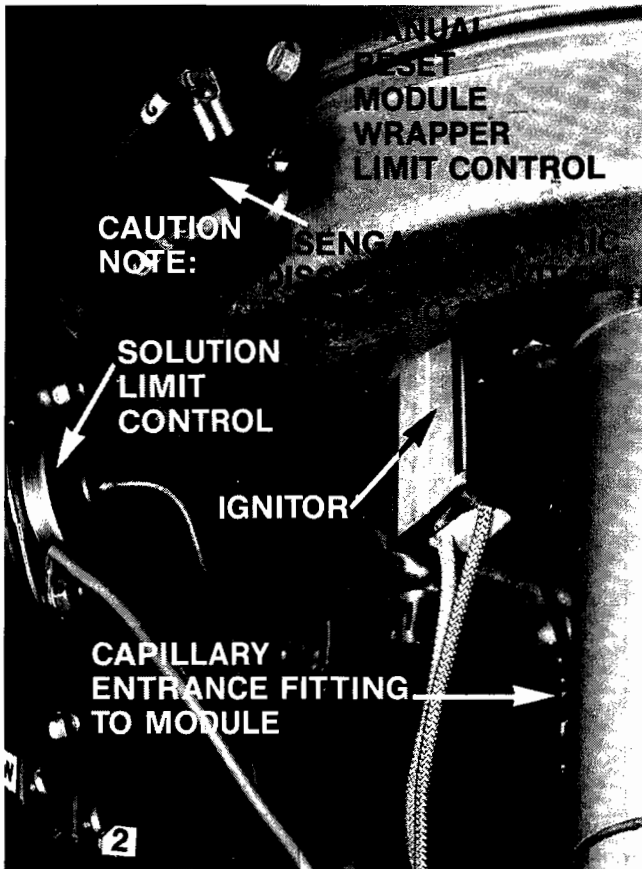

FIGURE 40

The normally open contacts in this control will close and cause the heating relay to stay energized so the solution pump can continue to run and cool the heating solution.

The normally closed contacts, which are now open, will interrupt the circuit to the electronic ignition module. The system will go through the normal ignition and heating cycle after the solution has been cooled and the limit control resets itself.

The cause for the overheated solution must be corrected (dirty filters, inoperative blower motor in the indoor air handler, insufficient ductwork, air in the solution piping, coil or module). The heating circuitry is broken when the room thermostat and/or the water heater thermostat is satisfied.

A secondary manual reset module wrapper limit control is secured to the lower portion of the heat transfer module. It is activated by a very high module temperature, such as, the system loss of the solution charge or air trapped in the solution. The control will stop the entire unit.

IMPORTANT: BE SURE TO DISENGAGE INDOOR AND OUTDOOR UNIT POWER DISCONNECT SWITCHES BEFORE PUSHING IN THE RESET BUTTON. It must be manually reset to again start the unit. The unit should be reset just once. If the unit goes out on limit again, the reason which caused the control to open must be ascertained and repaired. If unit doesn't start after pushing in the reset button and engaging the electric switch, the module may still be too hot. Wait 10 minutes and try again. If the limit must be replaced, a small amount of heat conductive compound M2755-20 must be applied to face of disc.

CLEANING OF FLUE PASSAGEWAYS (QUALIFIED SERVICEMAN ONLY)

1. Turn the electrical disconnect switch to the "OFF" position to de-energize the outdoor unit.
2. Close the manual gas valve. Remove the flue cap from the unit. Lift it upward.
3. Clean the outside of module fins with a stiff bottle brush. Do not damage fins or tubing.
4. Vacuum dirt and debris from bottom of module (between outer wrapper and fins).
5. Observe if there is a sooting condition. If sooting is evident it is a must that you contact your servicing dealer to correct the condition.
6. Replace flue cap. Open manual gas valve. Turn electrical disconnect switch to the "ON" position.

BURNER

The stainless steel burner in the HTM module is mounted vertical and the gas/air mixture is blown through thousands of openings. All lint, etc. is burned up and no rust can fall on the burner to plug openings.

FUNCTIONAL PARTS LIST

Description	ERGW0015-1A P68191-6F ERGW0015-1A P68191-7F	
	Qty.	Qty.
Hose, Suction, Inlet Pipe to Tee	1	1
Hose, Module Outlet	1	1
Hose, Suction, Pump to Tee	1	1
Hose, Pump Discharge	1	1
Hose, Tee to Exp. Tank	1	1
Limit Control, Auto Reset	1	1
Limit Control, Man., Reset	1	1
Wiring Harness, Ignition	1	1
Tank, Expansion	1	1
Flue Cap Weldment	1	1
Pad, Silencer (Top of HTM)	1	1
Bracket, Pad, Silencer (Top of HTM)	1	1
O Ring, Flue Cap to HTM Wrapper Seal	1	1
Ignition Control Module	1	
Plate, Orifice, 80M, Nat.	1	
Plate, Orifice, 100M, Nat.	1	
Plate, Orifice, 120M, Nat.	1	
Plate, Orifice, 80M LP	1	
Plate, Orifice, 100M, LP	1	
Plate, Orifice, 120M, LP	1	
Plate, Orifice, 130M, Nat.		1
Plate, Orifice, 150M, Nat.		1
Plate, Orifice, 130M, LP		1
Plate, Orifice, 150M, LP		1
Heat Transfer Module	1	
Gasket, Ignitor	1	1
Top Transition Tube	1	1
Ignitor	1	1
Gasket Burner	1	1
Relay, SPDT	1	1
Terminal Board	1	1
Capacitor, Pump, 15 mfd 370V	1	1
Gasket, Fan Scroll	1	1
Gasket, Transition	1	1
Gasket, Mixer	1	1
Transition Tube, Bottom	1	1
Base Mixer	1	1
Heat Conductive Compound	AR	AR
Heat Transfer Solution	AR	AR

Description	ERGW0012-1A P68191-6F ERGW0015-1A P68191-7F	
	Qty.	Qty.
Plate, Mixer	1	1
Gas Valve, Redundant	1	1
Combustion Blower	1	1
Pump/Motor Assy.	1	1
Heat Transfer Module Kit (includes module, burner, and transition basket)		1
Heat Transfer Kit (includes module, burner, and transition basket)	1	
Burner		1
Burner	1	
	EBWC3612M-B P68775-03F EBWC6012M-A P6977502F	
Description	Qty.	Qty.
Bracket, Motor Mtg.	1	1
Blower Housing	1	
Blower Housing		1
Blower Wheel	1	
Blower Wheel		1
Motor Blower	1	
Motor Blower		1
Capacitor 5 mfd. 370V	1	
Capacitor, 10 mfd 370V		1
Relay, SPDT	1	1
Terminal Board Transfer	1	1
Transformer, 40VA 115V	1	1
Restrictor - Heat Transfer Pipe	1	1
Fan Control Timer	1	1
Coil Heating	1	
Coil Heating		1
Filter, Permanent Washable 16" x 25" x 1		2

Specifications and quantities are subject to change without notice.

Order by description, model, manufacturing, and serial number.

The following must accompany the order when ordering in warranty parts: proof of purchase receipt plus model, manufacturing and serial number.

AR is required.

Order from your installing dealer.

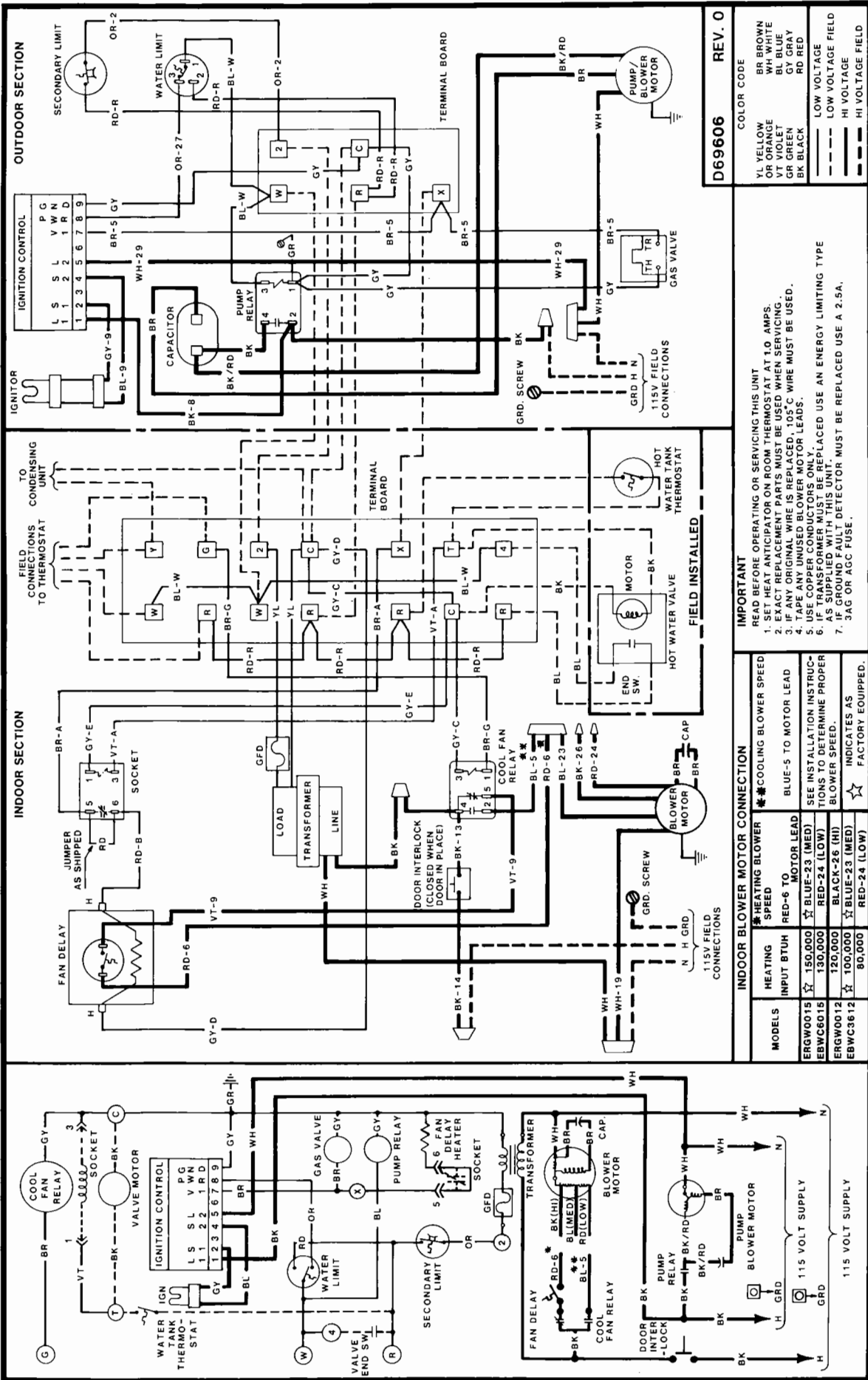

D69606 REV. 0

COLOR CODE

YL	YELLOW
OR	ORANGE
VT	VIOLET
GR	GREEN
BK	BLACK
RD	RED
BR	BROWN
WH	WHITE
BL	BLUE
GY	GRAY
RD	RED

---	LOW VOLTAGE FIELD
---	LOW VOLTAGE FIELD
---	HI VOLTAGE FIELD
---	HI VOLTAGE FIELD

IMPORTANT

1. SET HEAT ANTICIPATOR ON ROOM THERMOSTAT AT 1.0 AMPS.
2. EXACT REPLACEMENT PARTS MUST BE USED WHEN SERVICING.
3. IF ANY ORIGINAL WIRE IS REPLACED, 105°C WIRE MUST BE USED.
4. TAPE ANY UNUSED BLOWER MOTOR LEADS.
5. USE COPPER CONDUCTORS ONLY.
6. U.S. SUPPLY MUST BE USED TO REPLACE USE AN ENERGY LIMITING TYPE MOTOR WITH THIS UNIT.
7. IF GROUND FAULT DETECTOR MUST BE REPLACED USE A 2.5A, 3AG OR AGC FUSE.

ERGW0012-1A/EBWC3612M-B

ERGW0015-1A/EBWC6015M-A

